

**MasterCool®**

# Owner's Manual

## High Capacity Fan Evaporative Coolers

### CFD4200 • CFD4800 Series

For low static pressure  
installations in commercial,  
industrial and warehouse  
applications.

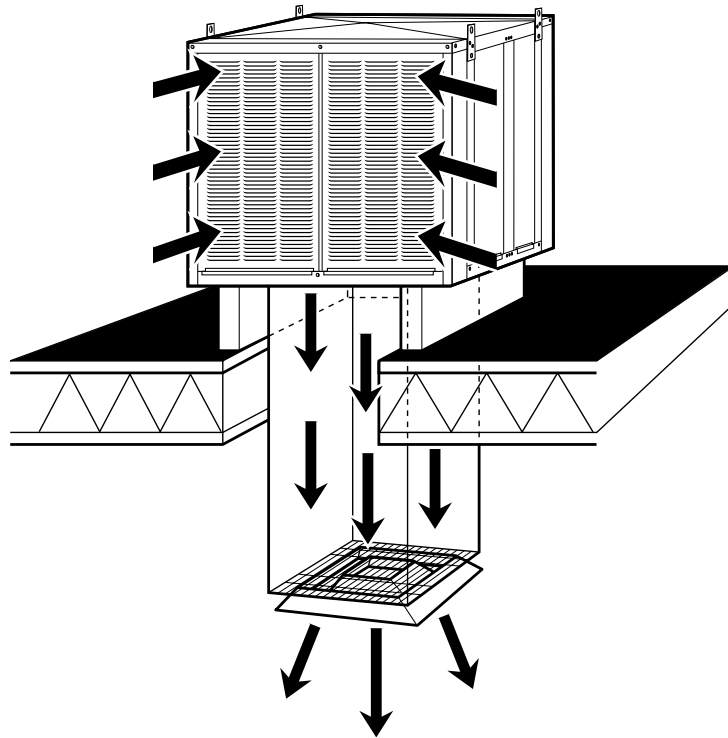

U.L. listed for  
non-ducted  
installations





**Read and Save this Manual.  
Important Safety Instructions Inside.**

Your air cooler was thoroughly tested and inspected before leaving the factory. This is your guide to economical, trouble free comfort cooling over the years with reasonable care and regular maintenance. **READ IT CAREFULLY.**

**Note:** Your warranty does not cover shipping damage. Report all shipping damage at once to dealer or carrier making delivery.

- Even while routinely inspecting or servicing the inside, the cooler can be accidentally started. Keep all personnel away from the cooler and electrical supply when you are working on it.
- Don't attempt to perform any part of the installation described in this book unless you are **FULLY QUALIFIED** to do so. All electrical work must meet local codes and national codes (N.E.C.) and must be performed by qualified personnel only.

 **Caution: Disconnect all electrical power to the cooler before attempting to install, open, or service your cooler. If the cooler is thermostatically controlled, the thermostat is not to be used as a disconnect for it may reset and start the unit unexpectedly.**

 **Caution: Do not allow pump to topple over and become submerged; water will damage pump motor.**

Before attempting to install the cooler, make sure the following preparations have been made:

- Assure that the mounting surface is strong enough to bear the weight of the cooler when in use, remember that when the system fills with water, the cooler will be much heavier than when dry. (For operating weight, see accompanying parts list.)
- Make sure you have adequate means for lifting the cooler in place.
- Check the electrical supply to see that it matches the requirements shown on the motor nameplate.
- Make sure the mounting surface is level in all directions.
- Make sure any duct work and electrical needs comply with local and national codes.

 **Caution: All electrical installations must comply with local building and safety codes and must be performed by qualified personnel only.**

### **LOCATION**

Down discharge commercial and industrial coolers are designed for installation on either flat or pitched roof.

### **DUCT SYSTEM**

This cooler is U.L Listed for non-ducted installations – it should be installed only with a short, vertical plenum with or without a simple diffuser at the bottom. Install cooler so only fresh outside air enters cooling system.

### **AIR EXHAUSTING**

Windows or doors at the most distant from cooled air inlet should be left open, or suitable vents or dampers should be installed, to permit free movement of air out of area being cooled, and avoid building up static pressure. Proper location of exhaust openings is important as they guide flow of air through areas where cooling is desired. Using standard CFM ratings, a common method for determining how much to open doors or windows for proper exchange is: 2 square feet per 1000 CFM.

### **COOLER ASSEMBLY**

The unit is shipped fully assembled from the factory, with motor and pump(s) installed and all internal wiring complete. No cabinet assembly is necessary.

### **ELECTRICAL INSTALLATION**

Be sure cooler is connected to proper line current, voltage and cycle as stamped on cooler motor and pump motor specification plate. Check with local power company if in doubt. Note: Improper voltage will void motor guarantee.

 **Caution: All electrical installations must comply with local building and safety codes, and must be performed by qualified personnel only. A wiring diagram is furnished separately with every cooler.**

Larger horsepower and three phase applications may require overload protection, such as, switches and/or starters of proper current capacity and should be installed by a competent electrician.

## **ELECTRICAL GROUND**

For a maximum safety precaution, make sure cooler cabinet is properly grounded to a suitable ground connection.

 **Caution: Disconnect all electrical power to the cooler before attempting to install, open, or service your cooler. If the cooler is thermostatically controlled, the thermostat is not to be used as a disconnect as it may reset and start the unit unexpectedly.**

 **Caution: Never operate unit with service panels, media or inlet panels removed. This will result in an overloaded condition and may damage the blower motor.**

## **GENERAL WIRING INSTRUCTIONS**

All installations must be completed in accordance with National Electric Code (N.E.C.) Article 110.

This cooler is completely pre-wired internally by the factory.

- The water pump(s) circuit is a separate 120 Volt, single phase circuit going to GFCI protected receptacles factory mounted inside the cooler for convenient plug-in of the factory supplied pump(s).
- The fan motor circuit is wired specific to the model purchased. A separate wiring diagram is furnished along with this Owners Manual

## **SAFETY DISCONNECT SWITCH**

Safety disconnect switch(es) must have minimum enclosure classification compatible with the installation location and installed in accordance with N.E.C., Article 430. The disconnect switch shall be a U.L. Listed disconnect which breaks all ungrounded conductors that can carry current to the unit.

## **OVER-CURRENT (SHORT CIRCUIT) PROTECTION**

Devices intended to protect the motor branch-circuit conductors, motor control apparatus and motors against over-current due to short circuits or ground faults shall have minimum enclosure classifications compatible with the installation location and installed in accordance with N.E.C., Articles 240 and 430. These devices shall be U.L. Listed

short circuit protection devices and sized in accordance with specifications as stated in N.E.C., Article 430.

## **OVERLOAD PROTECTION**

All single phase motors supplied with these coolers have integral thermal overload protection (running and locked rotor). All 3-phase motors supplied with these coolers require overload protection, sized and installed in accordance with N.E.C., Article 430 (see motor starter).

## **MOTOR START SWITCH**

In applications where a switch is adequate to start the motor, as defined by N.E.C., Article 430, the branch circuit shall be sized in accordance with N.E.C., Article 210 and 430. The enclosure for the switch and its location shall comply with N.E.C. requirements for the installation of the switch.

## **MOTOR STARTER**

A motor starter is a device with integral thermal overload protection used to start/stop 3-phase motors. Motor starters shall be sized in accordance with specifications as stated in the N.E.C., Article 430. Starters mounted to unit shall have minimum NEMA 3R (raintight-rainproof) enclosure rating. Starters mounted remote to the unit shall have minimum enclosure classification compatible with the installation location and installed in accordance with N.E.C., Article 430.

## **CONTROL CIRCUIT TRANSFORMER**

Shall be N.E.C. class 2 transformer of adequate capacity and installed in accordance to nationals and local codes.

## **PUMP TRANSFORMER**

When required, transformer shall have a minimum ampacity of 250 VA and have, or be located within, a minimum enclosure classification compatible with N.E.C., Article 450.

## **PUMP CIRCUIT**

The pump circuit, if not operating on a transformer, shall have over-current protection of 15 AMP or smaller and have a minimum of #14 AWG copper wire to the pump circuit supplied with the cooler.

### INSTALL OVERFLOW STANDPIPE AND DRAIN LINE

Install overflow drain bushing in bottom of cooler. Slide rubber washer over drain bushing, push drain bushing through bottom of cooler, and tighten nut. Screw plastic overflow standpipe into the drain bushing and tighten snugly to prevent leakage. Connect a drain (copper/pvc/garden hose) to drain bushing and drain in accordance to local codes.

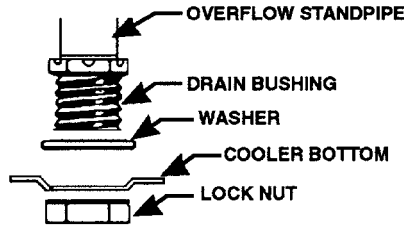

### CONNECT WATER SUPPLY

Connect water line to cooler as follows:

- A water valve should be installed at a convenient location, to allow the water supply to be turned on and off. 1/4" tubing is used to provide water to the cooler.
- Install float valve through hole provided.
- Place tube nut and ferrule over end of tubing.
- Insert tube into float valve, and tighten to secure.

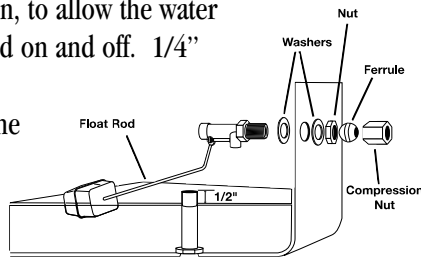

**Caution:** All plumbing installations must comply with local building and safety codes, and must be performed by qualified personnel only.

### ADJUSTING WATER LEVEL AND FLOAT VALVE

Fill reservoir as follows:

- Turn water supply on. Check for good pressure and flow from float valve.
- When float valve shuts off, check water level. Water level should be from 1/2 to 1 inch below the top edge of overflow standpipe.
- Adjust float valve by bending the rod.

### INSTALL BLEED-OFF

A bleed-off system has been provided with your cooler. Its purpose is to eliminate a small quantity of water from recirculation; this reduces scale build-up. This bleed-off assembly merely requires inserting the bleed-off hose into the pump assembly and routing bleed-line through standpipe opening.

1. Install bleed-line into pump assembly bleed-off tap.
2. Route far end of bleed-line into standpipe.
3. Install clamp with screw on bleed-line.
4. Adjust screw to obtain flow rate such that a 12 ounce beverage can is filled approximately every 30 seconds..
5. Water to be drained in accordance with local codes.

**Note:** Bleed rate may degrade slightly after two weeks and should be checked two to four weeks after initial setting and readjusted.

**Caution:** Disconnect all electrical power to the cooler before attempting to install, open, or service your cooler. If the cooler is thermostatically controlled, the thermostat is not to be used as a disconnect as it may reset and start the unit unexpectedly.

### PRE-START-UP INSPECTION

Before starting the cooler motor and pump to check out operation, make sure all installations and adjustments have been properly and thoroughly made. Assure that:

- Cooler mounting is level; duct is sealed.
- Cabinet is securely fastened to mounting.
- Cooler cabinet is grounded. Electrical connections are safe and secure.
- Motor, pump, and float installed.
- Pump impeller turns freely. Remove pump and basket. Remove impeller cover and spin the impeller to assure free rotation.
- Water lines connected securely without leaks. Water supply turned on.
- Float adjusted for proper water level.
- Pulley alignment okay, belt tension okay.

## **START-UP CHECK LIST**



**Caution:** *Never operate unit with service panels, media or inlet filter removed. This will result in an overloaded condition and may damage the blower motor.*

To check out installation, an initial start-up procedure should be followed.

- Check to see that the cooler is level.
- Check water level.
- Check for leaks.
- Check belt tension and condition.
- Check that setscrews and nuts on pulleys, fans and mounting brackets are tight.
- Open windows, doors or vents in building.
- Turn electrical supply on.
- Check to see that pump starts and pads are evenly wet.
- Check water distribution system for full even flow.
- Start blower by switching to cooling mode.
- Check for cool air delivery.

## **MAINTENANCE SCHEDULE**

Regular maintenance is a key to long successful service of your Industrial MasterCool cooler. The service will help you maintain an efficient unit with good appearance. Regular, careful maintenance will allow you to enjoy a long, more efficient service life from your cooler. Before starting any maintenance operation, read thoroughly all operating and maintenance instructions and observe all cautions and warnings.

**Note:** Do not undercoat the water reservoir. Your Industrial MasterCool cooler's water reservoir is finished with a Polybond appliance type finish. It is so hard asphalt type cooler undercoat will not stick to it. Undercoat will break free and clog pump and water distributor. The use of chemical additives or any water treatment other than bleed-off is not recommended for this cooler.

## **CLEANING AND INSPECTION**

For maximum efficiency, longer life and appearance, every two months during operation the cooler should be inspected and cleaned. All foreign materials, scale, salt

deposits, lime, etc. can and should be removed from louvers or inlet screens, bottom pan, and other components. Your coolers long lasting finish can be brought to like-new condition by using warm water and soft cloth. Do not clean fan motor with this method. Motors damaged by water are NOT covered under warranty. Avoid scouring pads, steel wool, and wire brushes, as these will damage the finish and encourage corrosion.

**Warning:** Never wash your cooler cabinet with a garden hose; water may harm motor and pump or seep into ductwork.

**Important:** Before operating cooler at beginning of each cooling season, turn fan, cooler motor and pump motor shafts by hand to make sure they turn freely. Failure to do so may result in burning out motor.

## **MAINTENANCE**

Regular maintenance as recommended in this manual is essential for cooling comfort, extending the life of your cooler, and avoiding unnecessary parts replacements. Startup and shutdown servicing should never be overlooked.

## **PERIODIC INSPECTION**

In addition to the planned maintenance schedule, regular inspection of your Industrial MasterCool cooler will enhance the chance for long trouble free service life.

## **CHECKLIST**

- Check for leaks.
- Are there any dry spots on the pads when cooler is in operation?
- Are bolts, nuts, and set screws snug?
- Is cooler level?
- Does fan turn freely?
- Is float set correctly?
- Is water pan clean?
- Proper belt tension?

## **ADJUST BELT TENSION**



**Caution:** *Disconnect all electrical power to the cooler and insure that belt is not rotating before adjusting belt tension.*

Adjust belt tension only by adjusting motor bracket. Each time you inspect your cooler, be sure to check belt tension on motor/fan assembly. Check belt condition and replace it if frays or defects appear. Check alignment of fan pulley with motor pulley.

### **CLEANING WATER PUMP**

 **Caution:** Do not allow pump to topple over and become submerged; water will damage pump motor.

 **Caution:** Disconnect all electrical power to the cooler before attempting to install, open, or service your cooler. If your cooler is thermostatically controlled, the thermostat is not to be used as a disconnect as it may reset and start the unit unexpectedly.

Disassemble and clean water pump as follows:

- With power supply disconnected, unplug pump cord.
- Remove pump.
- To prevent breakage, carefully release the four snap-out tabs, and lift impeller base plate from the pump body.
- Using a mild detergent solution, wash all deposits from inside around impeller and impeller base plate.
- Spin impeller to dislodge any foreign material.
- Rinse and reinstall impeller base plate.
- Reinstall pump.
- Connect cord.

### **CHANGING AND WASHING MEDIA**

This should be done after 5 years or if passage is clogged. Note: Hosing off inlet face of media can unclog passages of dust, and minerals accumulated there. Light scraping of the intake edges of the media will not harm its openings and will remove more stubborn scale.

**Caution:** Avoid splashing water on blower motor.

### **MEDIA REPLACEMENT**

- Remove media section top.
- Remove water distributor assembly, disconnecting hose.
- Lift out used media sections.

- Replace with new MasterCool media only. Aspen and other evaporative media WILL NOT WORK.
- Replace water distributor assembly, reconnect hose.
- Replace media section top.

### **DRAINING AND CLEANING THE CABINET**

 **Caution:** Disconnect all electrical power to the cooler before attempting to install, open, or service your cooler. If the cooler is thermostatically controlled, the thermostat is not to be used as a disconnect as it may reset and start the unit unexpectedly.

**Warning:** Never wash your cooler cabinet with a garden hose; water may harm motor and pump or seep into ductwork.

Clean the cooler cabinet (with power off and panels removed) as follows:

- Connect a drain hose to the drain fitting on the bottom of the reservoir.
- Remove standpipe from the drain fitting.
- Drain and clean reservoir. (Never drain water onto a roof).

### **TOUCH-UP**

The hardness, adhesion and smoothness of the finish on your cooler makes it extremely unlikely that scratches or chipping will occur, in the event that finish damage does occur, it should be promptly repaired by the following procedures:

**Painted Parts:** The area around bare metal spots, either internal or external, should be sanded or rubbed with steel wool to prepare the finish, primed and painted with standard paint, or with matching touch up paint, available through your dealer. Do not use asphalt type cooler undercoat material in water reservoir.

### **REPLACEMENT PARTS**

When ordering replacement parts, always refer to the serial and model number of your cooler.

**TROUBLESHOOTING**

The following troubleshooting guide is intended to address the most common symptoms and is by no means exhaustive. If symptoms persist, call a qualified serviceman. Only a certified electrician should complete electrical work. Turn off all power to the cooler before attempting to troubleshoot any of the following symptoms.

<b>SYMPTOM</b>	<b>POSSIBLE CAUSES</b>	<b>REMEDY</b>
<b>Unit fails to start or deliver air</b>	<ol style="list-style-type: none"> <li>1. No electrical power to unit                             <ol style="list-style-type: none"> <li>A. Fuse blown</li> <li>B. Circuit breaker tripped</li> </ol> </li> <li>2. Belt improperly adjusted or broken</li> <li>3. Motor overheated and/or frozen                             <ol style="list-style-type: none"> <li>A. Belt too tight or broken</li> <li>B. Faulty wiring or shorts</li> </ol> </li> </ol>	<ol style="list-style-type: none"> <li>1. Check power                             <ol style="list-style-type: none"> <li>A. Replace fuse*</li> <li>B. Reset breaker*</li> </ol> <i>* If condition persists, call electrician</i> </li> <li>2. Adjust belt tension</li> <li>3. Replace motor                             <ol style="list-style-type: none"> <li>A. Adjust belt tension or replace</li> <li>B. Call electrician</li> </ol> </li> </ol>
<b>Unit starts but air delivery inadequate</b>	<ol style="list-style-type: none"> <li>1. Lack of sufficient air exhaust</li> <li>2. Belt too loose</li> </ol>	<ol style="list-style-type: none"> <li>1. Open windows or doors to increase ventilation</li> <li>2. Adjust belt tension or replace if needed</li> </ol>
<b>Inadequate cooling</b>	<ol style="list-style-type: none"> <li>1. Inadequate exhaust in building</li> <li>2. Insufficient water/pad not wet                             <ol style="list-style-type: none"> <li>A. Pads plugged/clogged</li> <li>B. Dry or open spots on pads</li> <li>C. Water trough holes clogged</li> <li>D. Pump not working</li> <li>E. Loose connections in water system</li> <li>F. Distributor clogged or corroded</li> <li>G. Insufficient bleed-off water</li> <li>H. Pump basket clogged</li> </ol> </li> </ol>	<ol style="list-style-type: none"> <li>1. Open windows or doors to increase ventilation</li> <li>2. Check water distribution system                             <ol style="list-style-type: none"> <li>A. Replace pads</li> <li>B. Repack pads</li> <li>C. Clean troughs and unplug holes</li> <li>D. Disconnect pump. Clean impeller housing of foreign matter and reinstall</li> <li>E. Check for leaks and correct</li> <li>F. Clean or replace</li> <li>G. Reset or replace bleed-off kit</li> <li>H. Clean or replace</li> </ol> </li> </ol>
<b>Motor cycles or fails to operate</b>	<ol style="list-style-type: none"> <li>1. Excessive belt tension</li> <li>2. Pulleys misaligned</li> <li>3. Faulty wiring or shorts</li> </ol>	<ol style="list-style-type: none"> <li>1. Adjust belt tension</li> <li>2. Check and correct alignment</li> <li>3. Call electrician</li> </ol>
<b>Water flowing from overflow standpipe</b>	<ol style="list-style-type: none"> <li>1. Float arm improperly adjusted</li> <li>2. Seat in float valve leaking</li> <li>3. Standpipe not tight</li> </ol>	<ol style="list-style-type: none"> <li>1. Adjust float</li> <li>2. Replace float valve</li> <li>3. Tighten standpipe</li> </ol>
<b>Knocking or banging sound</b>	<ol style="list-style-type: none"> <li>1. Fan blades rubbing fan shroud</li> <li>2. Loose parts</li> </ol>	<ol style="list-style-type: none"> <li>1. Inspect fan, belt and pulley alignment and motor mounting</li> <li>2. Tighten, secure or reconnect</li> </ol>
<b>Musty or unpleasant odor</b>	<ol style="list-style-type: none"> <li>1. Stale or stagnant water in reservoir</li> <li>2. Pads mildewed or clogged</li> <li>3. Pads not completely wet before cooler turned on</li> </ol>	<ol style="list-style-type: none"> <li>1. Drain, flush and clean reservoir, install bleed-off kit</li> <li>2. Check bleed-off setting, Replace pads</li> <li>3. Turn on water before starting unit</li> </ol>
<b>Excessive humidity in building</b>	<ol style="list-style-type: none"> <li>1. Inadequate exhaust in building</li> </ol>	<ol style="list-style-type: none"> <li>1. Open doors or windows to increase ventilation</li> </ol>

### **EVAPORATIVE COOLER LIMITED WARRANTY**

AdobeAir, Inc., Phoenix, Arizona, extends this limited warranty to the original purchaser of an AdobeAir Evaporative Cooler installed and used under normal conditions.

- I. Five Year Coverage-applies to wet section cabinet only. At our option, we will exchange or repair the wet section bottom pan assembly should any water leakage occur through the base assembly due to rust out during the first five years after date of initial purchase.
- II. One Year Coverage-applies to all components (e.g. motor, pump, float, bearings). We will exchange any part (except cooler pads), which fails as a result of original material or workmanship during the first year after date of initial purchase.
- III. What This Warranty Does Not Cover:
  - a. We are not responsible for any damage or malfunction unless a result of original material or workmanship. Damage or malfunction, which is not covered by this warranty, includes, but is not limited to, water damage to the motor, abuse, misuse, alteration, improper installation/maintenance/operation or transportation damage.
  - b. This warranty does not cover any failure or damage that results from unauthorized modification or service; or from the use of products or replacement parts other than those from AdobeAir; including, but not limited to, motors and pumps.
  - c. Mineral accumulations, dirt and dust on the pads are not defects and are excluded from this warranty. Cooling pads are a disposable item and their life span depends on local conditions.
  - d. This warranty does not cover the cost of service call at the site of installation to diagnose cause of trouble, the cost of labor or mileage allowance to or from site to replace a defective part, or freight/postage on any exchange.
  - e. This warranty does not cover evaporative coolers installed and operated outside the continental United States.
- IV. To obtain service under this warranty, contact the dealer where you purchased the cooler. As a final step, or if you cannot locate your dealer, contact Customer Service, AdobeAir, Inc. Include your name, full address and phone number; the servicing dealer involved, the model and serial numbers of your cooler; the date of installation; and a description of your problem.

This warranty is the only warranty extended by AdobeAir to suppliers and/or consumer purchasers of this evaporative cooler. AdobeAir disclaims all other warranties, express or implied, that arise by the operation of the law, except that implied warranties of merchantability of fitness for a particular purpose are limited to the duration of the warranty period. AdobeAir shall not be liable for any incidental or consequential damage, which may have resulted from any alleged breach of warranty.

Some states do not allow limitations on how long an implied warranty lasts or the exclusion or limitation of incidental or consequential damages, so the above limitations or exclusions stated above may not apply to you.

This warranty gives you specific legal rights, and you may have other right, which vary from state to state.

**NOTE:** There will be a slight odor that may be noticed during the initial start-up. The odor will disappear within the first few days of operation if proper bleed-off is used as instructed.

Since AdobeAir, Inc. follows a policy of continuous product improvement, it reserves the right to change design and specifications without prior notice or liability.

**AdobeAir, Inc.**

500 South 15th Street • Phoenix, Arizona 85034  
602 257-0060 • 602 257-1349 fax  
email: Warranty@AdobeAir.com  
www.AdobeAir.com